

# The Original Seat Valve

## SRC Sanitary Remote-Controlled Valve

### Application

SRC is an air-operated seat valve in a sanitary and flexible design giving a wide field of application, e.g. as a stop valve with two or three ports or as change-over valve with three to five ports.

### Working principle

The valve is remote-controlled by means of compressed air. It has few and simple moveable parts which results in a very reliable valve.

### Standard design

SRC consists of actuator, lip seal, plug and valve bodies. All components are assembled by means of clamp rings and a stem clip-system. For sizes DN125 and DN150, the piston and valve plug are screwed together. In order to facilitate installation the valve is only partly assembled when delivered. The valve has welding ends as standard.

SRC, sizes DN125 and DN150 are very heavy. Therefore it is recommended to manufacture and use auxiliary handling equipment. Guidelines are given in IM 70007.

The recommended auxiliary equipment cannot be supplied by Alfa Laval.

### Actuator function

- Pneumatic downward movement, spring return (NO).
- Pneumatic upward movement, spring return (NC).
- Pneumatic upward and downward movement (A/A), sizes 25-101.6mm/DN25-100.
- Actuator for intermediate position of the valve plug as option sizes 25-101.6mm/DN25-100.

### Other valves in the same basic design:

- Aseptic Manual and Remote controlled valve, type ARC/AMO.
- Sanitary Long Stroke valve, type SRC-LS.
- Sanitary Manual valves, type SMO/SMO-R.
- Sanitary Reverse Closing valve, type SRC-RC.

See also PD 60789, PD 65142, PD 65143 and PD66320.



Fig. 1. SRC valve with valve body combination 21.

### Valve body combinations

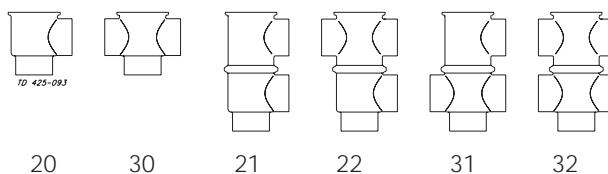

Pressure drop/capacity diagrams

Stop valve

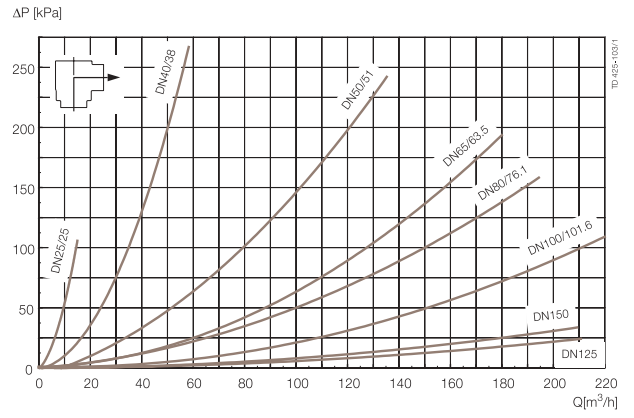
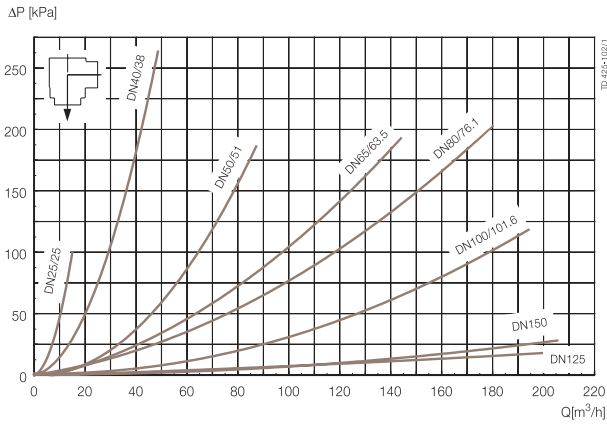

Change-over valve

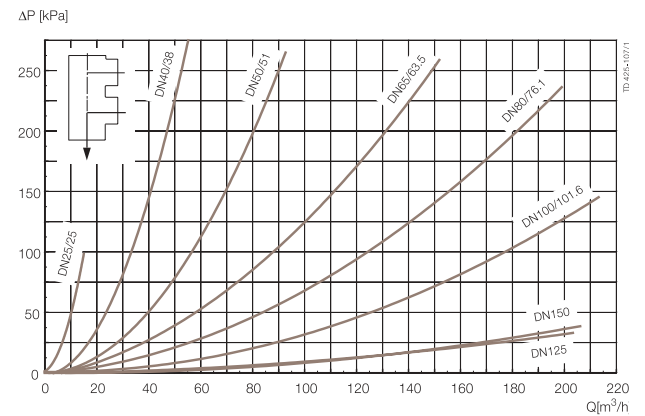
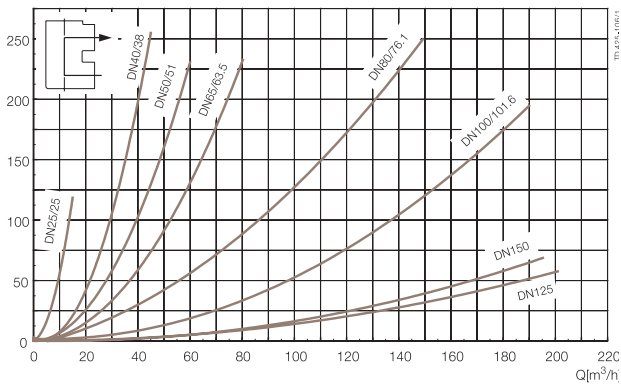
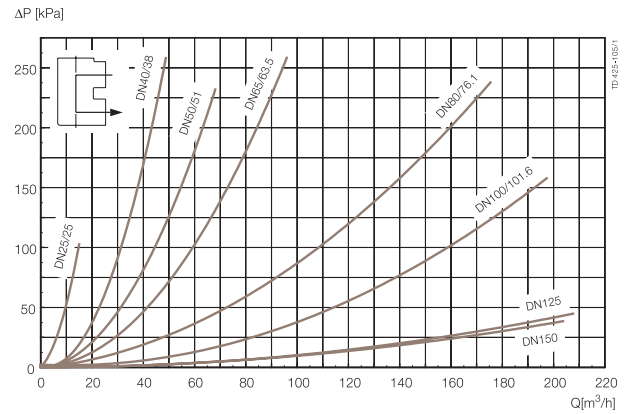
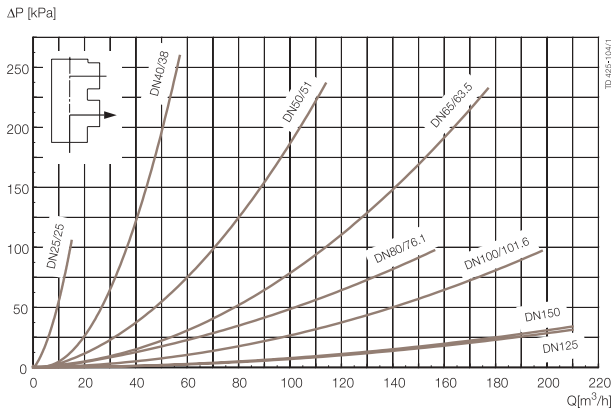







**NOTE!** For the diagrams the following applies:  
 Medium: Water (20°C).  
 Measurement: In accordance with VDI 2173.

Pressure data for SRC

Actuator type / function

- 10. Pneumatic downward movement, spring return (NO-lower seat)
- 20. Pneumatic upward movement, spring return (NC-lower seat)
- 30. Pneumatic upward and downward movement (A/A), (not sizes DN125 and DN150).
- 60. Three-positions (NO-lower seat) (not sizes DN125 and DN150).
- 70. Three-positions (NC-lower seat) (not sizes DN125 and DN150).

Table 1: Stop and change-over valves  
- Max. pressure without leakage at the valve seat

Actuator / Valve body combination and direction of pressure	Air pressure (bar)	Actuator type/function	Valve size								
			Type	DN25 25 mm	DN40 38 mm	DN50 51 mm	DN65 63.5 mm	76.1 mm	DN80	DN100 101.6 mm	DN 125-150
 Spring closes		10(NO)		9.5	4.5	4.5	3.0	5.0	5.0	3.5	5.2
		60(NO)		9.5	4.5	4.5	3.0	5.0	5.0	3.5	5.2
 Air closes	5	10(NO)	ISO	Min.10	7.0	4.0	3.0	4.0	3.2	2.5	8.7
	5		DIN	Min.10	6.0	3.6	3.0	4.0	3.2	2.5	8.7
	6	10(NO)	ISO	Min.10	10.0	5.5	4.0	6.0	4.8	4.0	4.4
	6		DIN	Min.10	8.5	5.0	4.0	6.0	4.8	4.0	4.4
 Air closes	5	20(NC)		9.5	4.5	4.5	3.0	4.5	4.5	2.5	8.1
	6	70(NC)		Min.10	6.5	6.5	4.0	7.0	7.0	4.0	3.7
 Spring closes		20(NC)	ISO	Min.10	7.0	4.0	2.5	5.0	4.0	3.5	5.2
		70(NC)	DIN	Min.10	6.0	3.6	2.5	5.0	4.0	3.5	5.2
 Air closes	5	30(A/A)		Min.10	9.0	9.0	8.0	Min.10	Min.10	7.5	
	6			Min.10	Min.10	Min.10	9.0	Min.10	Min.10	9.0	
 Air closes	5	30(A/A)	ISO	Min.10	10.0	9.0	6.0	Min.10	8.0	7.5	
	5		DIN	Min.10	8.5	8.2	6.0	Min.10	8.0	7.5	
	6		ISO	Min.10	Min.10	Min.10	7.0	Min.10	9.4	9.0	
	6		DIN	Min.10	9.1	8.5	7.0	10	9.4	9.0	

 = Values are valid for air pressure of 8 bar.

 = Actual product pressure.

Pressure data for SRC

Table 2: Stop and change-over valves

The table shows the approx. static pressure (P) in bar against which the valve can open.









Actuator / Valve body combination and direction of pressure	Air pressure (bar)	Actuator type/ function	Type	Valve size								
				DN25 25 mm	DN40 38 mm	DN50 51 mm	DN65 63.5 mm	DN76.1 76.1 mm	DN80 80	DN100 101.6 mm	DN125-150 125-150	
 <p>Spring opens</p>		10(NO)	ISO	Min.10	9.0	6.0	4.0	7.5	6.5	5.0	8.8	
		60(NO)	DIN	Min.10	7.7	5.5	4.0	7.5	6.5	5.0	8.8	
 <p>Air opens</p>	6	10(NO)		Min.10	7.5	7.5	5.5	9.0	7.5	6.0	8.1	
	6	60(NO)		Min.10	7.5	7.5	5.5	9.0	7.5	6.0	min. 10	
 <p>Air opens</p>	6	20(NC)	ISO	Min.10	10.0	7.5	5.0	9.0	7.5	6.0	7.8	
	6	70(NC)	DIN	Min.10	8.5	6.8	5.0	9.0	7.5	6.0	7.8	
 <p>Spring opens</p>		20(NC)		Min.10	6.0	6.0	5.0	7.5	6.5	5.0	8.9	
		70(NC)		Min.10	6.0	6.0	5.0	7.5	6.5	5.0	8.9	

Table 3: Stop and change-over valves with extra strong springs or special cylinder (not for sizes DN125-150)

- Max. pressure without leakage at the valve seat

Actuator / Valve body combination and direction of pressure	Air pressure (bar)	Actuator type/ function	Extra strong spring						Spec. actuator (dia. 133 mm)		
			Valve size DN						Valve size DN		
			DN40 38 mm	DN50 51 mm	DN65 63.5 mm	DN76.1 76.1 mm	DN80 80 mm	DN100 101.6 mm	40 38 mm	50 51 mm	65 63.5 mm
 <p>Spring closes</p>		10(NO) 60(NO)	6.5	6.5	4.0	7.0	7.0	4.5	9.0	9.0	6.0
	5	10(NO)	2.0	0.0	0.0	0.0	0.0	0.0	10.0	8.5	6.0
 <p>Air closes</p>	5	10(NO)	1.7	0.0	0.0	0.0	0.0	0.0	8.5	7.7	6.0
	6	60(NO)	2.0	2.0	1.0	1.0	1.0	1.0	*	*	*
 <p>Air closes</p>	6	60(NO)	1.7	1.8	1.0	1.0	1.0	1.0	*	*	*
	5	20(NC)	0.0	0.0	0.0	0.0	0.0	0.0	9.0	9.0	6.0
 <p>Spring closes</p>	6	70(NC)	2.0	2.0	1.0	1.0	1.0	1.0	*	*	*
		20(NC)	9.0	5.5	3.5	7.0	5.0	4.5	10.0	9.0	6.0
	70(NC)	7.7	5.0	3.5	7.0	5.0	4.5	8.5	8.2	6.0	

○ = Values are valid for air pressure of 8 bar.

□\* = Do not exceed 5 bar air pressure.

Dimensions (mm)

Nominal size	Inch DN/OD						DIN DN									
	25	38	51	63.5	76.1	101.6	25	40	50	65	80	100	125		150	
													NC	NO	NC	NO
A <sub>1</sub>	311	345	355	389	455	527	311	343	354	386	456	526	571	573	584	586
A <sub>2</sub>	332	370	380	414	487	559	332	368	379	411	488	558	614	618	627	631
A <sub>3</sub>	365	416	449	500	584	677	365	414	448	497	585	676	740	737	777	775
A <sub>4</sub>	387	441	474	525	616	709	387	439	473	522	617	708	781	778	818	816
C	55.6	79	94	113	129	163	55.6	79	94	113	129	160	167	167	192	192
OD	25.2	38.1	50.8	63.5	76.1	101.6	29	41	53	70	85	104	129	129	154	154
ID	22.2	34.9	47.6	60.3	72.1	97.6	26	38	50	66	81	100	125	125	150	150
t	1.5	1.6	1.6	1.6	2.0	2.0	1.5	1.5	1.5	2.0	2.0	2.0	2.0	2.0	2.0	2.0
E <sub>1</sub>	30.1	49.5	62	82	87	134	32	49.5	62	82	87	134	150	150	150	150
E <sub>2</sub>	57	49.5	62	82	87	134	57	49.5	62	82	87	134	150	150	150	150
F <sub>1</sub>	21	25	25	25	32	32	21	25	25	25	32	32	43	45	43	45
F <sub>2</sub>	20	25	25	25	32	32	20	25	25	25	32	32	41	41	41	41
H	87	87	87	87	133	133	87	87	87	87	133	133	199	199	199	199
M/ISO clamp	21	21	21	21	21	21										
M/DIN clamp							21	21	21	21	21	21				
M/ISO male	21	21	21	21	21	21										
M/DIN male							22	22	23	25	25	30	46	46	50	50
M/SMS male	20	20	20	24	24	35										
M/BS male	22	22	22	22	22	27										
Weight (kg)																
Stop valve:	5.0	4.9	5.0	5.4	12.4	13.0	5.0	4.9	5.0	5.4	12.4	13.0	40.3	40.3	40.9	40.9
Change-over valve:	5.8	5.9	6.1	6.8	14.6	15.9	5.8	5.9	6.1	6.8	14.6	15.9	50	50	51.3	51.3

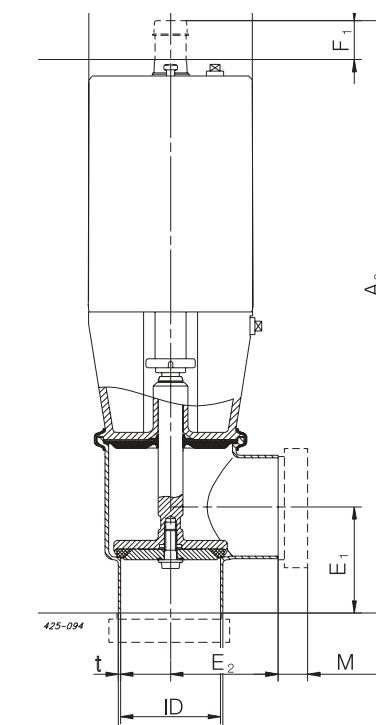

a. Stop valve.

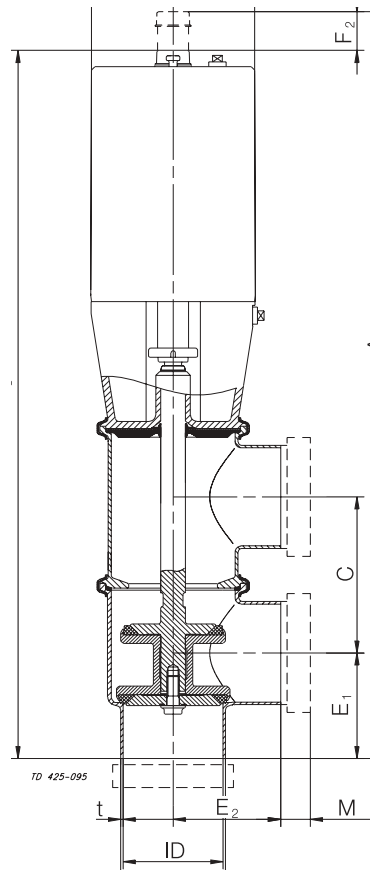

b. Change-over valve.

**Caution, opening/closing time:**

Opening/closing time will be effected by the following:

- The air supply (air pressure).
- The length and dimensions of the air hoses.
- Number of valves connected to the same air hose.
- Use of single solenoid valve for serial connected air actuator functions.
- Product pressure.

**Air Connections**

**Compressed air:**

R 1/8" (BSP), internal thread.

Fig. 2. Dimensions.

**Technical data**

Max. product pressure: .....	1000 kPa (10 bar).
Min. product pressure: .....	Full vacuum.
Temperature range, standard lip seal: .....	-10°C to +100°C (EPDM)
special lip seal: .....	-10°C to +140°C (EPDM)
Air pressure, actuator	
- Sizes 25-101.6 mm /DN25-100 .....	500 to 700 kPa (5 to 7 bar)
- Sizes DN125-150 .....	600 to 800 kPa (6 to 8 bar)

Air consumption (litres free air) for one stroke				
Size	25-63.5 mm DN 25-65	76-101.6 mm DN 80-100	DN 125-150	DN 125-150
Stop valve/ Change-over valve	0.2 x Air pressure (bar)	0.7 x Air pressure (bar)	1.5 x Air pressure (bar)	2.2 x Air pressure (bar)
Actuator function	NO and NC	NO and NC	NC	NO
Stop valve/ Change-over valve	0.4 x Air pressure (bar)	1.3 x Air pressure (bar)	3.6 x Air pressure (bar)	2.9 x Air pressure (bar)
Actuator function	A/A	A/A	NC (Support air for closing)	NO (Support air for opening)

**Materials**

Product wetted steel parts: .....	Acid-resistant steel AISI 316L.
Finish: .....	Semi bright.
Other steel parts: .....	Stainless steel AISI 304.
Plug stem	
- Sizes 25-101.6 mm/DN25-100 .....	AISI 316L with hard chrome plated stem surface
- Sizes DN125-150 .....	AISI 316L
Product wetted seals .....	EPDM (standard)
Other seals .....	Nitrile (NBR)
Alternative product wetted seals .....	Nitrile (NBR) and Fluorinated rubber (FPM), PTFE/FEP

**Options**

- A) Male parts or clamp ends in accordance with required standard.
- B) Control and Indication (see chapter in Product Catalogue).
- C) Damper against water hammer applicable for sizes 25 - 101.6 mm/DN25 - 100.
- D) Actuator with stronger spring applicable for sizes 38 - 101.6 mm/DN40 - 100 .
- E) Larger actuator for valve sizes 38-51mm, DN 40-65.
- F) Stainless steel seal disc replacing standard lip seal.
- G) Two-step or three-position actuator applicable for sizes 25 - 101.6 mm/DN25 - 100
- H) Tangential side port valve.
- I) Surface roughness, product wetted parts:  $Ra \leq 0.8 \mu m$ .
- J) Product wetted seals of Nitrile (NBR), Fluorinated rubber (FPM) or PTFE.
- K) Service tools for actuator.

**Ordering**

Please state the following when ordering:

- Size.
- Connections if not welding ends.
- Valve body combination.
- Actuator function, NC, NO or A/A, A/A for sizes 25 - 101,6 mm/DN25 - 100.
- Options.

**Note!** For further details, see also PD 65036, PD 65152 and instruction IM 70007.