

When Size Matters

Small Single Seat Valve

Application

The Small Single Seat Valve with its sanitary and flexible design is applicable for a wide range of tasks either as a stop valve with two or three ports or as a change-over valve with three to five ports.

The valve is suitable for use in food, beverage, dairy and pharmaceutical industries.

Working principle

The valve is remote-controlled by means of compressed air or manually operated.

The small single seat valve is very reliable due to its simple design and few moving parts.

Standard design

The Small Single Seat Valve is available as DN/OD 12.7 mm and 19 mm and consists of actuator, sealing element, lip seal, plug and valve bodies.

The plug is a PVDF plug. All components are assembled by means of clamp rings whereas the piston and valve plug have a threaded connection. In order to facilitate installation the valve is only partly assembled when delivered. The valve has welding ends or clamp ends as standard.

Actuator function

- Pneumatic downward movement, spring return (NO).
- Pneumatic upward movement, spring return (NC).
- Manually operated.

Valve body combinations

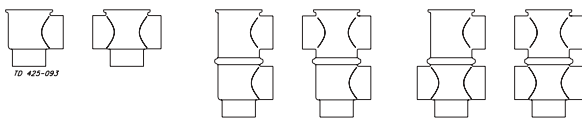

20 30 21 22 31 32



Fig. 1. Pneumatic and manual Small Single Seat Valve.

Pressure drop/capacity diagrams

Stop valve

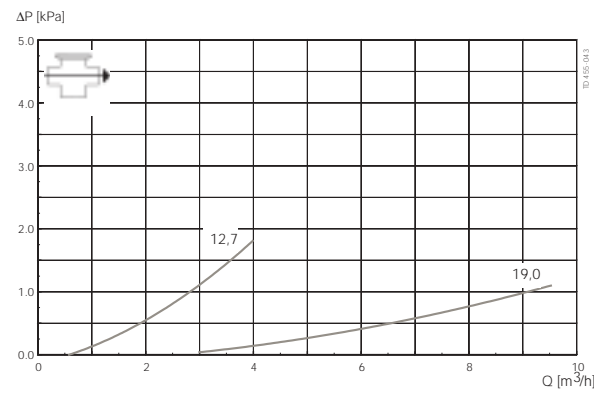
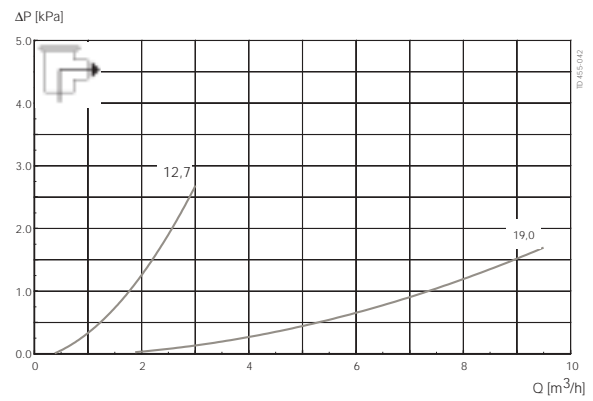
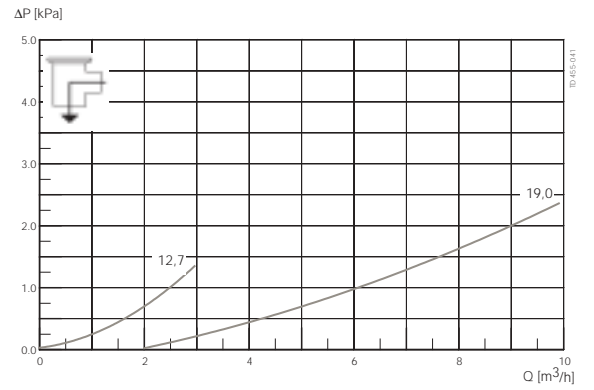

Change-over valve

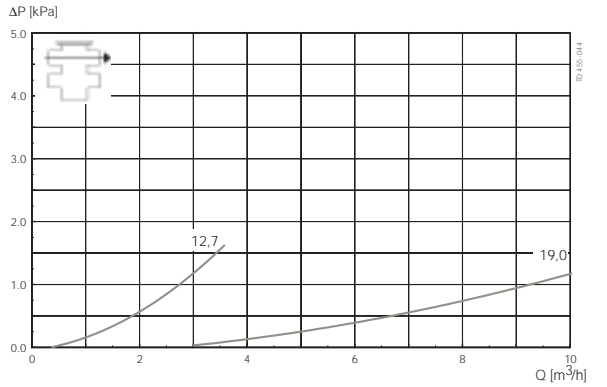
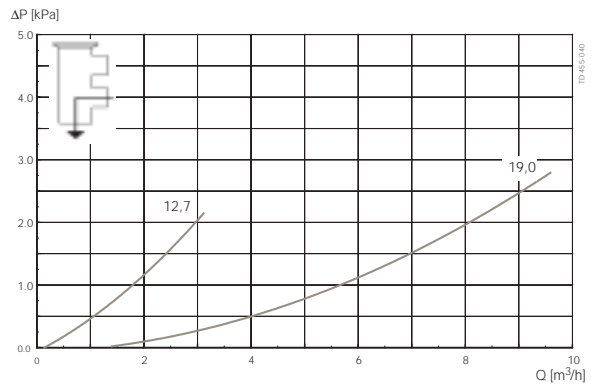
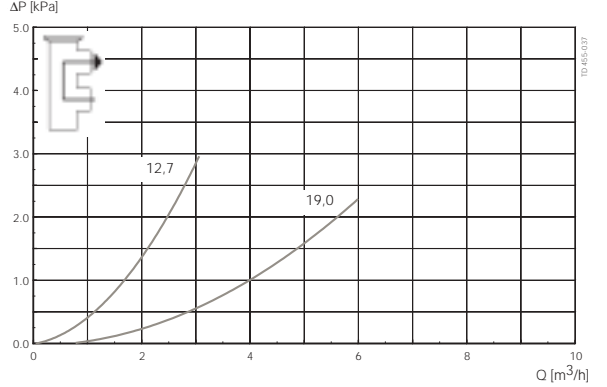
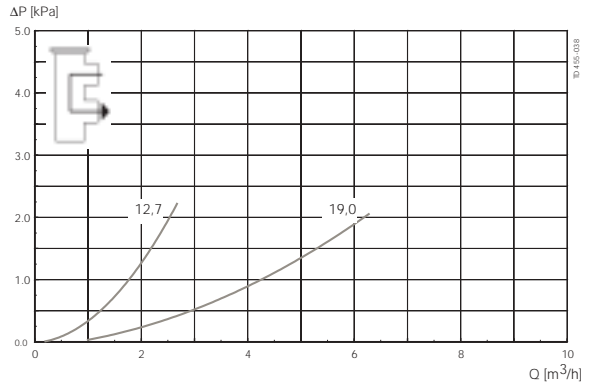
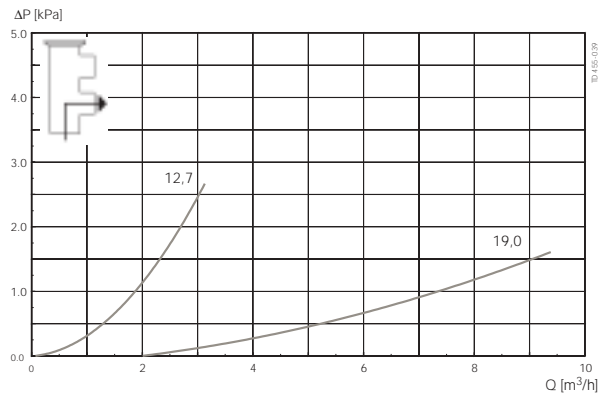

NOTE! For the diagrams the following applies:
 Medium: Water (20°C).
 Measurement in accordance with VDI 2173.





Pressure data for Small Single Seat Valve

Actuator type / function

10. Pneumatic downward movement, spring return (NO-lower seat)

20. Pneumatic upward movement, spring return (NC-lower seat)

Table 1: Stop and change-over valve. The table shows the approx. static pressure (p) in bar without leakage at the valve seat.

Actuator / Valve body combination and direction of pressure	Air pressure (bar)	Actuator type/function	Valve size	
			DN/OD 12.7 mm	DN/OD 19 mm
 Spring closes		10(NO)	Min.10	Min.10
 Air closes	2 3 4	10(NO) 10(NO) 10(NO)	2.0 Min. 10	- 3.0 Min.10
 Air closes	2 3	20(NC) 20(NC)	9.0 Min.10	- Min.10
 Spring closes		20(NC)	Min.10	Min.10





 = Actual product pressure.

Table 2: Stop and change-over valves.

The table shows the approx. static pressure (p) in bar against which the valve can open.

Actuator / Valve body combination and direction of pressure	Air pressure (bar)	Actuator type/function	Valve size	
			DN/OD 12.7 mm	DN/OD 19 mm
 Spring opens		10(NO)	Min.10	Min10
 Air opens	2 3 4	10(NO) 10(NO) 10(NO)	9.0 Min. 10 -	- 6.0 Min. 10
 Air opens	2	20(NC)	Min.10	Min.10
 Spring opens		20(NC)	Min.10	Min.10

Dimensions (mm)

Nominal size	Remote-controlled	
	DN/OD 12.7mm	DN/OD 19mm
A ₁	172.2	171.2
A ₂	179.2	182.2
A ₃	200.2	209.2
A ₄	207.2	220.2
C	32.3	38.1
OD	12.7	19.0
ID	9.5	15.8
t	1.6	1.6
E ₁	29.8	29.9
E ₂	45.0	45.0
F ₁	7.0	11.0
F ₂	7.0	11.0
H	57.0	57.0
Weight (kg) Stop valve	1.07	1.10
Weight (kg) Change-over valve	1.36	1.41

Caution, opening/closing time:

Opening/closing time will be effected by the following:

- The air supply (air pressure).
- The length and dimensions of the air hoses.
- Number of valves connected to the same air hose.
- Use of single solenoid valve for serial connected air actuator functions.
- Product pressure.

Air Connections

Compressed air:

R 1/8" (BSP), internal thread.

(900-233)

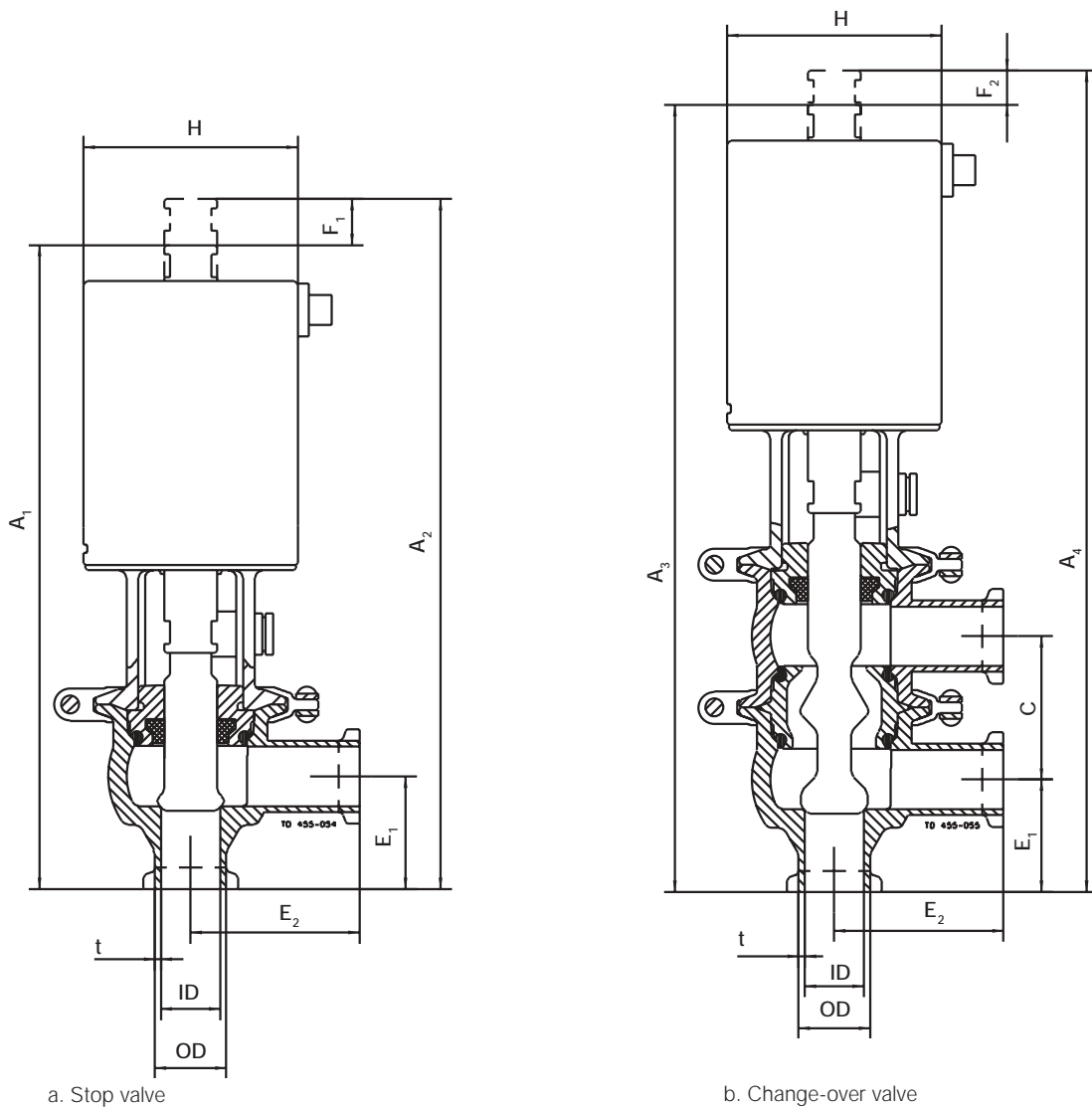

Dimensions (mm)

Nominal size	Manually operated	
	DN/OD 12.7mm	DN/OD 19mm
A ₁	109.7	112.7
A ₂	116.7	123.7
A ₃	141.7	150.7
A ₄	148.7	161.7
C	32.3	38.1
OD	12.7	19.0
ID	9.5	15.8
t	1.6	1.6
E ₁	29.8	29.9
E ₂	45.0	45.0
F ₁	7.0	11.0
F ₂	7.0	11.0
H	35.0	35.0
Weight (kg) Stop valve	0.5	0.53
Weight (kg) Change-over valve	0.8	0.85

Caution, opening/closing time:

Opening/closing time will be affected by the following:

- The air supply (air pressure).
- The length and dimensions of the air hoses.
- Number of valves connected to the same air hose.
- Use of single solenoid valve for serial connected air actuator functions.
- Product pressure.

Air Connections

Compressed air:

R 1/8" (BSP), internal thread.

(900-233)

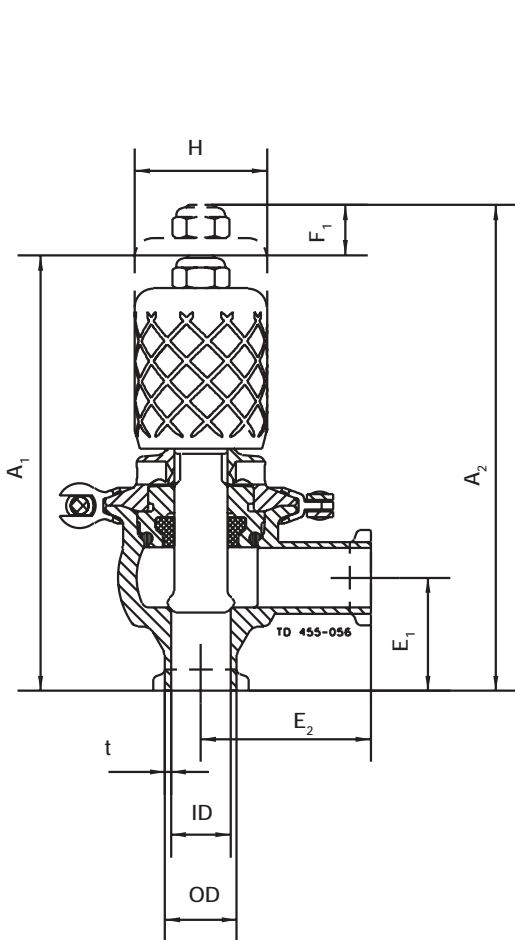

a. Manual stop valve

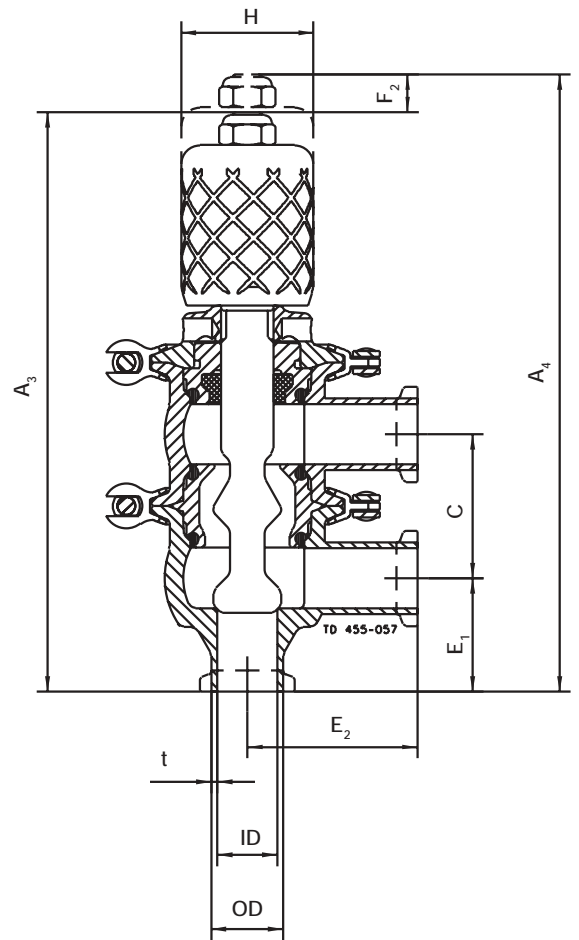

b. Manual change-over valve

Technical data

Max. product pressure: 1000 kPa (10 bar).
 Min. product pressure: Full vacuum.
 Temperature range: -10°C to +140°C (EPDM).
 Air pressure: 100 to 700 kPa (1 to 7 bar).

Air consumption (litres free air) for one stroke	
Size	12.7-19 mm
Stop valve/ Change-over valve	0.06 x Air pressure (bar)
Actuator function	NO and NC

Product wetted steel parts: Acid-resistant steel 1.4404 (AISI 316L).
 Finish: outside: Semi bright.
 inside: Ra ≤ 0.5µm.
 Other steel parts: Stainless steel 1.4307 (AISI 304L).
 Plug: PVDF.
 Product wetted seals: EPDM rubber.
 Actuator seals: Nitrile (NBR).
 Alternative product wetted seals: HNBR, FPM.

Options

- A) 3.1.B Certificate.
- B) Adapter for *ThinkTop*®.
- C) Automation: See chapter in Product Catalogue.
- D) Product wetted seals of HNBR or fluorinated rubber (FPM).
- E) Clamp with wingnut

Ordering

Please state the following when ordering:

- Size.
- Body with welding ends or clamp ends.
- Valve body combination.
- Actuator function, NC or manual.
- Options.

Note! For further details, see also PD 65036 and instruction IM 70860.